

# Easy One Touch 5

Dash/Windshield Mount · Support pour tableau de bord/pare-brise  
Supporto telefono per parabrezza/cruscotto · Armaturen Brett/  
Windschutzscheibenhalterung · Montaje de tablero/parabrisas

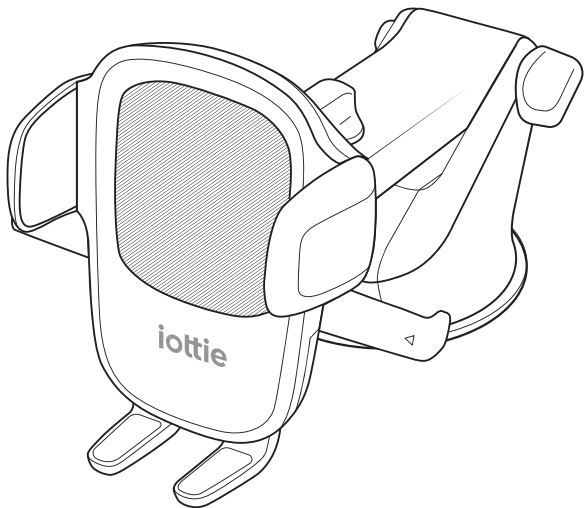

Manual · Guide · Manuale · Handbuch · Manual







**iottie**

# Easy One Touch 5

Dash/Windshield Mount

User Manual

	English	.....	04
	French	.....	10
	Italian	.....	16
	German	.....	22
	Spanish	.....	28

# Getting Started

For optimal mounting, please follow the detailed instructions within this manual when using the Easy One Touch 5. iOttie is not liable for possible damages due to product misuse.

## Critical Information

The dashboard pad features a semi-permanent adhesive. Each pad is for one-time use only. Once removed, it cannot be re-mounted. When mounting, it is recommended that the surface & product be above 65°F.

## Specifications

ITEM	SPECIFICATIONS
DEPTH	6.5"
WIDTH	4.2"
HEIGHT	3.9"
WEIGHT	7.2 oz

**!** Telescopic arm extends from 4.5 inches to 6.75 inches.

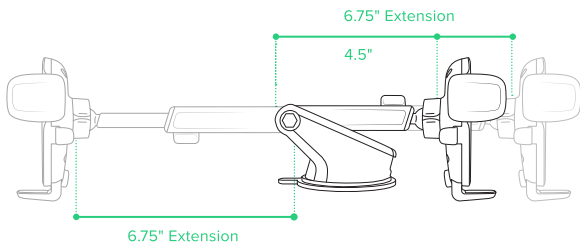

# At a Glance

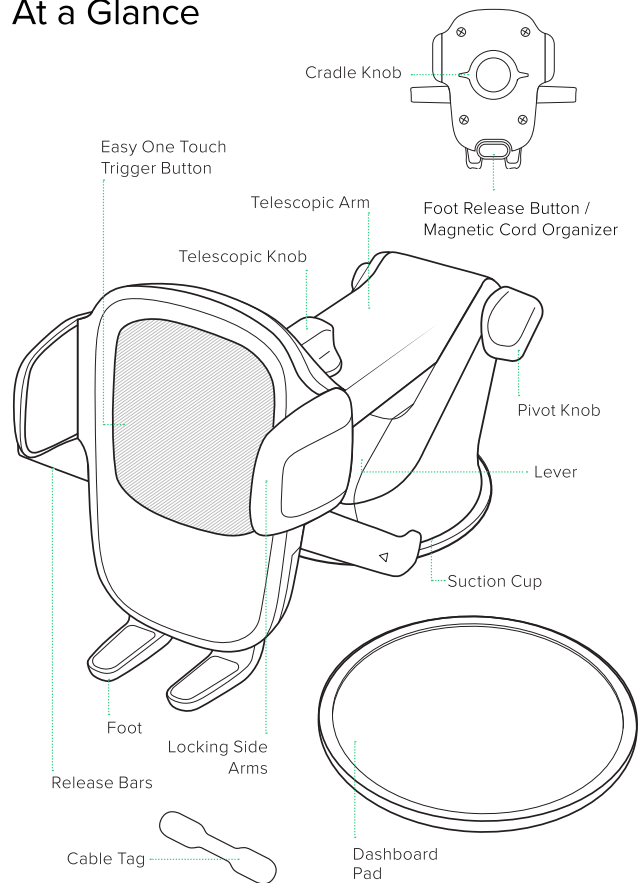

# Installation

## Assembling the Mount

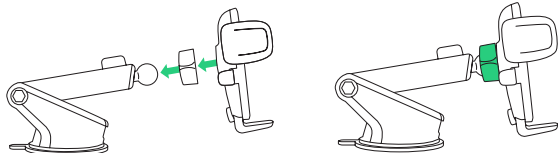

1. Attach the mount cradle to the ball joint.

2. Tighten the cradle knob.

## Attaching the Mount

Choose an installation method: Dashboard/Flat Surface (A) or Windshield/Curved Glass (B).

! If your vehicle has a leather dashboard, we recommend windshield mounting to avoid damaging your dash.

### [ Option A ] Dashboard or Flat Surface Installation

Choose a flat location on the vehicle's dashboard and wipe any dust or debris from the surface.

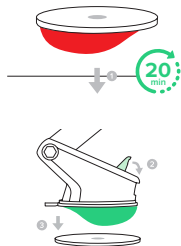

1. Peel off the film on the dashboard pad and evenly press onto the desired installation location. Wait at least 20 minutes before attaching the mount to ensure a secure hold.

2. Remove the plastic cover from the suction cup and firmly press the mount onto the dashboard pad.

3. Push the locking lever down to engage suction.

! When removing the dashboard pad, please use caution. We recommend removing slowly from the edge to avoid damage.

### [ Option B ] Windshield or Curved Glass Installation

Choose a location on the windshield and wipe any dust or debris from the surface.

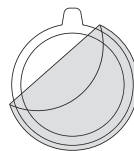

1. Peel off the protective film on the suction cup and press firmly onto the windshield.

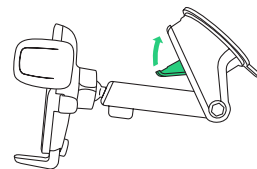

2. Push the locking lever down to engage suction.

! The dashboard pad is not recommended for windshield mounting.

## Additional Information

! To reuse the suction cup, simply rinse under warm water and let air dry to restore tacky suction.

! Use the magnetic cord organizer to keep your cord in place and out of the way.

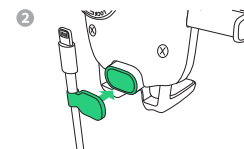
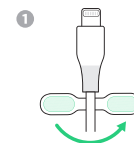

# Using the Easy One Touch Mechanism

The Easy One Touch lock and release mechanism makes it simple to mount & retrieve smartphones in seconds.

## Mounting

1. Squeeze the release bars on either side of the mount to open the locking side arms.

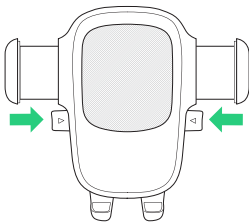

2. Press your device against the Easy One Touch trigger button. The mount's arms will automatically close on contact for a secure hold.

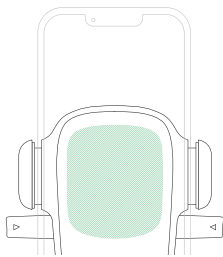

## Releasing

Press the release bars. The arms will open so you can retrieve your device.

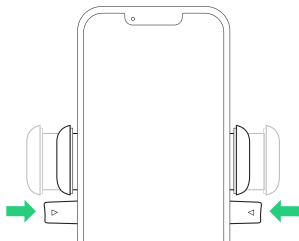

# Adjusting the Mount

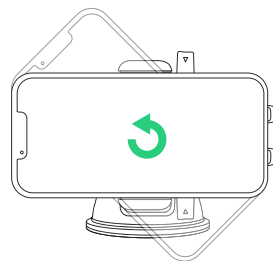

## Cradle knob

When switching between landscape and portrait mode, loosen the cradle knob to rotate the cradle. Tighten the knob to lock the mount in your desired position.

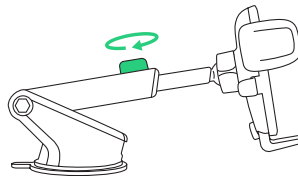

## Telescopic knob

Located on top of the telescopic arm, the knob can be loosened to extend the arm and tightened to secure the arm in place.

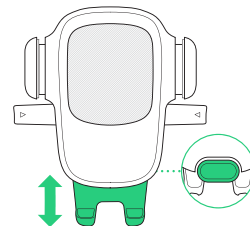

## Foot button

Located at the back of the cradle, the foot button can be used to reposition the bottom foot to fit larger phones.

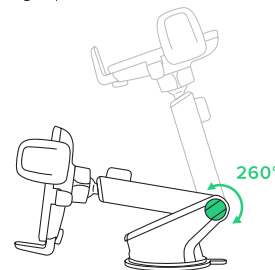

## Pivot knob

Located on the side of the mount base, you can loosen the pivot knob to move the telescopic arm up or down. Tighten the knob to lock the arm into position.

# Commencer

Pour un montage optimal, veuillez suivre les instructions détaillées de ce manuel lorsque vous utilisez l'Easy one Touch 5. iOttie n'est pas responsable des dommages éventuels causés par une mauvaise utilisation du produit.

## Information cruciales

La plaquette de tableau de bord est montée sur un ruban adhésif semi permanent. Chaque plaquette est à usage unique. Une fois retirée, elle ne peut être remise. Avant de fixer le produit, nous recommandons que la surface et le produit soient au-dessus de 65°F.

## Spécifications

OBJET	SPÉCIFICATIONS
LONGUEUR	16.5 cm
LARGEUR	10.7 cm
HAUTEUR	9.9 cm
POIDS	204 g

! Le bras télescopique se déploie de 11.4 cm à 17.2 cm.

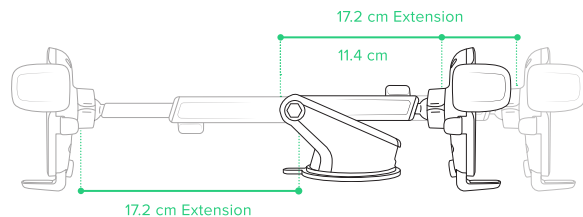

# Aperçu

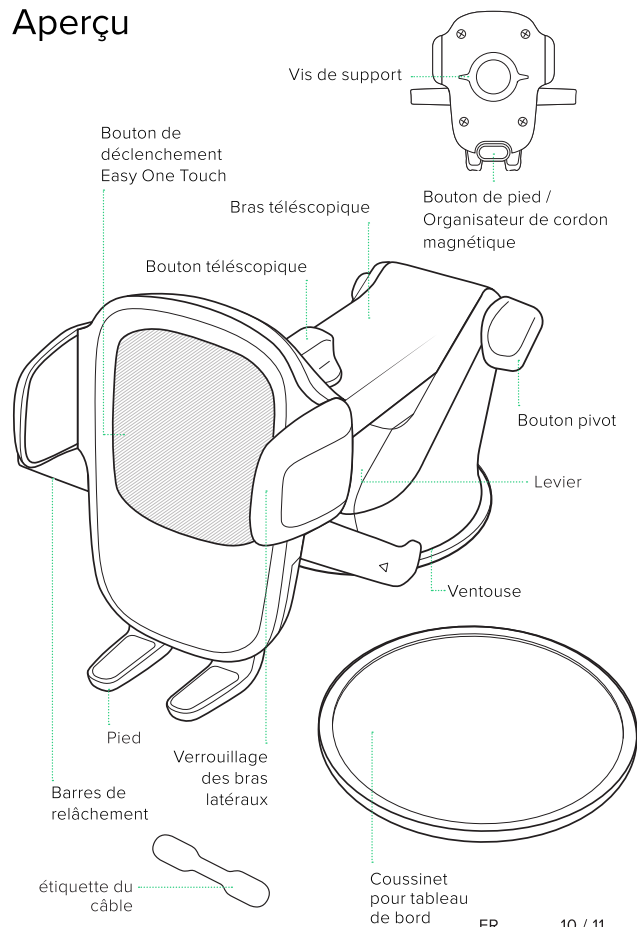

# Installation

## Assemblage du montage

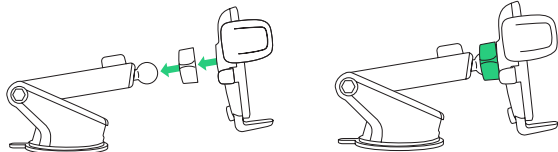

1. Connectez le support de montage avec la rotule d'attelage.
2. Serrez le bouton du berceau.

## Fixation du support

Choisissez une méthode d'installation: tableau de bord/surface plane (A) ou pare-brise/verre incurvé (B).

! Si votre véhicule est équipé d'un tableau de bord en cuir, nous vous recommandons une fixation au pare-brise pour éviter d'endommager votre tableau de bord.

### [ Option A ] Installation sur tableau de bord ou sur surface plane

Choisissez une zone sur une surface plane du tableau de bord du véhicule et éliminez toute poussière ou débris de la surface.

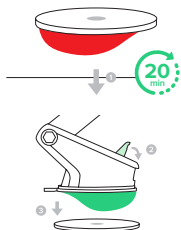

1. Retirez le film du tableau de bord puis collez-le sur le lieu d'installation désiré. Attendez 20 minutes pour que l'adhésif adhère avant de ne pas passer à l'étape suivante.
2. Retirez le film protecteur de la ventouse puis appuyez-la fermement sur la surface plane du tableau de bord.
3. Enclenchez le levier de verrouillage vers le bas pour mettre en oeuvre la suction.

! Lorsque vous retirez le tableau de bord, faites attention, nous vous recommandons de le retirer lentement à partir du bord pour éviter tout dommage.

### [ Option B ] Installation sur pare-brise ou installation sur verre incurvé

Choisissez un emplacement sur le pare-brise et éliminez toute poussière ou débris de la surface.

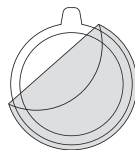

1. Retirez le film protecteur de la ventouse puis appuyez-la fermement sur le pare-brise.

! Il n'est pas recommandé d'utiliser le disque du tableau de bord pour le montage au pare-brise.

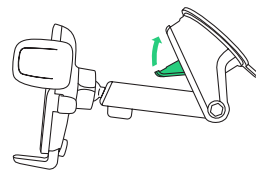

2. Enclenchez le levier de verrouillage vers le bas pour mettre en œuvre la suction.

## Informations supplémentaires

! Pour réutiliser la ventouse, rincez-la simplement à l'eau chaude et laissez-la sécher à l'air afin de rétablir l'aspiration.

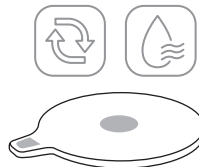

! Utilisez l'organisateur de cordon magnétique pour maintenir votre cordon en place et à l'écart.

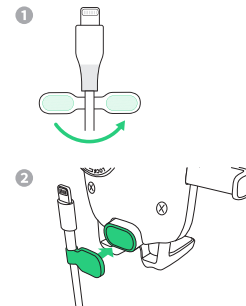

# Utilisation du mécanisme Easy One Touch

Le mécanisme de verrouillage et de dégageur Easy One Touch facilite le montage et le retrait rapide des smartphones.

## Montage

1. Appuyez sur les bras de verrouillage latéraux.

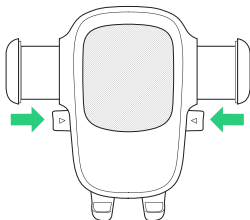

2. Appuyez votre appareil contre le bouton d'enclenchement Easy One Touch. Les bras de montage se fermeront automatiquement au contact et maintiendront l'appareil au cours de la conduite.

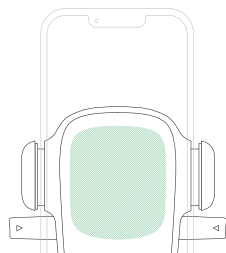

## Libération

Appuyez sur les bras de verrouillages latéraux avec une main et récupérez l'appareil.

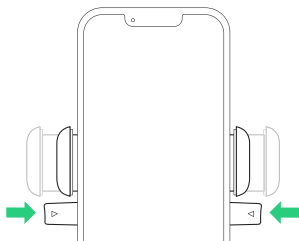

# Ajustement de l'assemblage

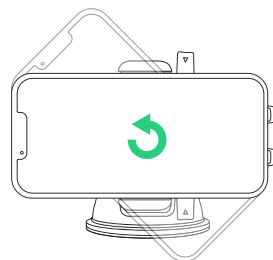

## Bouton du berceau

Lors du montage en mode paysage, relâchez le bouton du berceau pour faire pivoter le support. Resserrer pour verrouiller dans la position désirée.

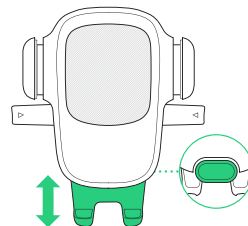

## Bouton de pied

Situé à l'arrière du Support. Appuyez sur le bouton pour repositionner le pied du support. Le pied peut être ajusté de haut en bas pour s'adapter à n'importe quel téléphone.

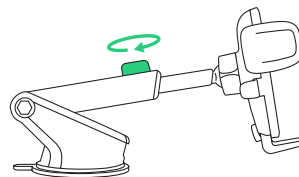

## Bouton télescopique

Localisé en haut du bras télescopique, relâcher pour étendre le bras, et resserrer pour sécuriser la longueur.

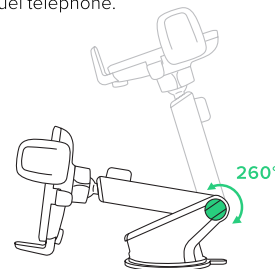

## Bouton pivot

Localisé sur le côté de la base de support, tourner vous permet de pivoter le bras télescopique. Resserrer pour sécuriser la position.



# Iniziamo

Per un montaggio ottimale, si prega di seguire le istruzioni dettagliate all'interno di questo manuale quando si usa il Easy One Touch 5. iOttie non è responsabile per eventuali danni causati da un uso improprio del prodotto.

## Informazioni critiche

Il pannello del cruscotto è montato con un nastro adesivo semipermanente. Ogni pad è di utilizzare una sola volta. Una volta rimosso, non può essere rimontato. Prima di montare il prodotto, si consiglia di utilizzare la superficie e il prodotto al di sopra dei 65° F.

## Specifiche

OGGETTO	SPECIFICHE
LUNGHEZZA	16.5 cm
LARGHEZZA	10.7 cm
ALTEZZA	9.9 cm
PESO	204 g

! Il braccio telescopico si estende da 11,4 cm a 17,2 cm.

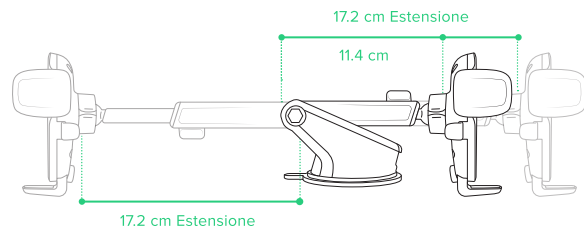

## A prima vista

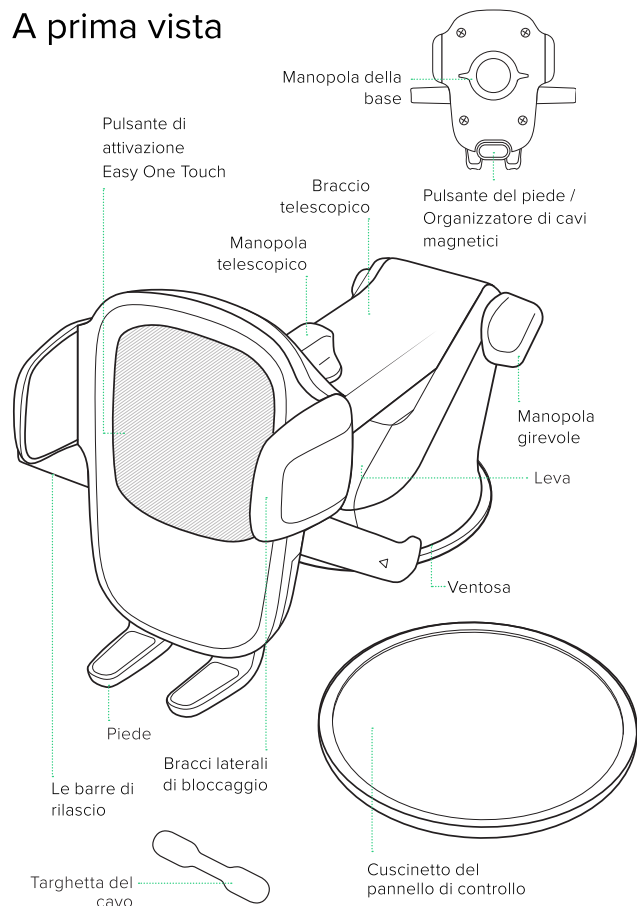

# Installazione

## Il montaggio del supporto

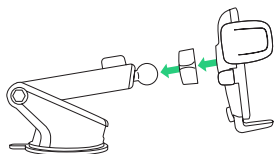

1. Collegare la base del supporto con il giunto sferico.

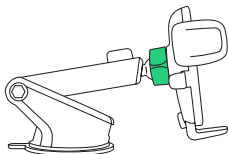

2. Stringere la manopola della base.

## Collegare il supporto

Scegliere un metodo di installazione: Cruscotto/superficie piana (A) o parabrezza/vetro curvo (B).

! Se il vostro veicolo ha un cruscotto in pelle, raccomandiamo l'installazione sul parabrezza per evitare danni.

### [ Opzione A ] Installazione su cruscotto/superficie piana

Scegliere un'area su una superficie piana sul cruscotto del veicolo e asciugare la polvere o i detriti dalla superficie.

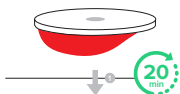

1. Staccare il film sul cruscotto e attaccarlo sul luogo di installazione desiderata. Aspettare 20 minuti perché l'adesivo sia ben fissato prima di procedere al passo successivo.



2. Staccare la pellicola protettiva sulla ventosa e premere saldamente il supporto sul cruscotto.

3. Premere la leva di bloccaggio verso il basso per attivare l'aspirazione.

! Si prega di fare attenzione durante la rimozione del tappetino per cruscotto, si consiglia di rimuoverlo lentamente dal bordo per evitare danni.

### [ Opzione B ] L'Installazione sul parabrezza o vetro curvo

Scegliere una posizione sul parabrezza e asciugare la polvere o i detriti dalla superficie.

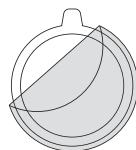

1. Staccare la pellicola protettiva sulla ventosa e premere saldamente il supporto sul parabrezza.

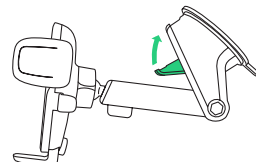

2. Premere la leva di bloccaggio verso il basso per attivare l'aspirazione.

! Si sconsiglia l'uso del tappetino per cruscotto durante il montaggio sul parabrezza.

## Ulteriori informazioni

! Per riutilizzare la ventosa, semplicemente sciacquare sotto l'acqua calda e lasciare asciugare all'aria per rendere la ventosa nuovamente appiccicosa.

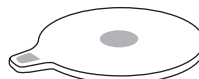

! Utilizza l'organizzatore del cavo magnetico per mantenere il cavo in posizione e lontano.

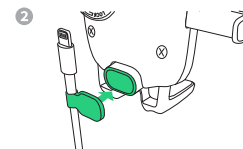
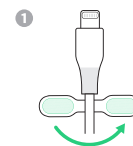

# Utilizzo del meccanismo Easy One Touch

Il meccanismo di blocco e rilascio Easy One Touch semplifica il montaggio e il recupero degli smartphone in pochi secondi.

## Il montaggio

1. Premere i bracci laterali di bloccaggio.

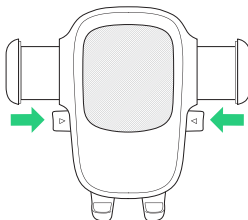

2. Premere il dispositivo contro il pulsante di attivazione Easy One Touch. I bracci del supporto chiuderanno automaticamente al contatto e terranno il dispositivo durante il viaggio.

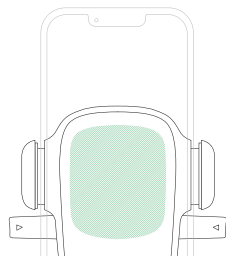

## Il Rilascio

Premere i bracci laterali di bloccaggio con una mano e recuperare il dispositivo.

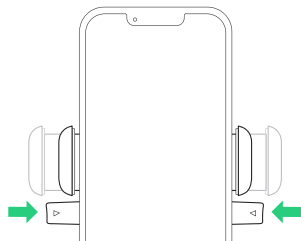

# Regolazione del Supporto

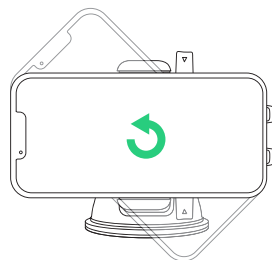

## Manopola della base

Per montare in modalità orizzontale, allentare la manopola della base per ruotare la base. Stringere per bloccare nella posizione desiderata.

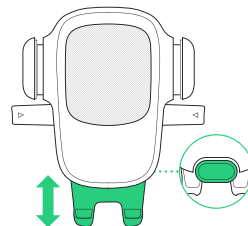

## Pulsante del piede

Situato sul retro del supporto. Premere il pulsante per riposizionare i supporti del pedale. Il pedale può essere regolato in alto e in basso per adattarsi a tutte le dimensioni del telefono.

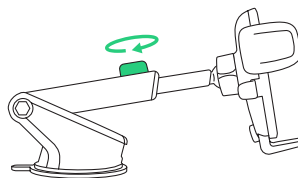

## Manopola telescopico

Situato sulla parte superiore del braccio telescopico, allentare per estendere il braccio e stringere per allacciare la distanza.

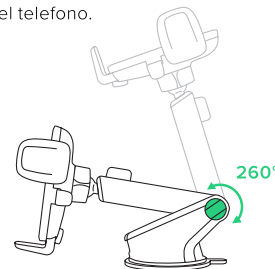

## Manopola girevole

Situato sul lato della base del supporto, la rotazione si lascia di ruotare il braccio telescopico. Stringere per allacciare la posizione.

## Erste Schritte

Befolgen Sie für einen optimalen Einbau die detaillierten Anweisungen in diesem Handbuch, wenn Sie das Easy One Touch 5 verwenden. iOttie haftet nicht für mögliche Schäden, die auf Grund einer unsachgemäßen Verwendung des Produkts entstehen.

## Kritische Information

Das Armaturenbrett-Pad ist mit einem semipermanenten Klebeband befestigt. Jedes Pad wird nur einmal verwendet. Einmal entfernt, kann es nicht wieder montiert werden. Wir empfehlen, dass die Oberfläche eine Temperatur von über 65 ° F aufweist, bevor Sie das Produkt befestigen.

## Spezifikationen

ARTIKEL	SPEZIFIKATIONEN
TIEFE	16.5 cm
BREITE	10.7 cm
HÖHE	9.9 cm
GEWICHT	204 g

! Der Teleskoparm erstreckt von 11,4 cm bis 17,2 cm.

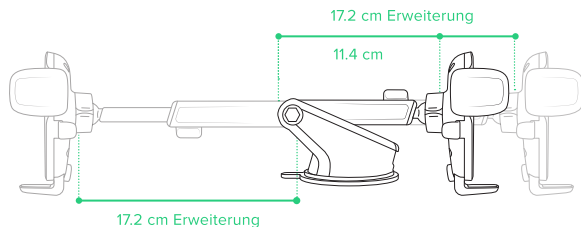

## Auf einen Blick

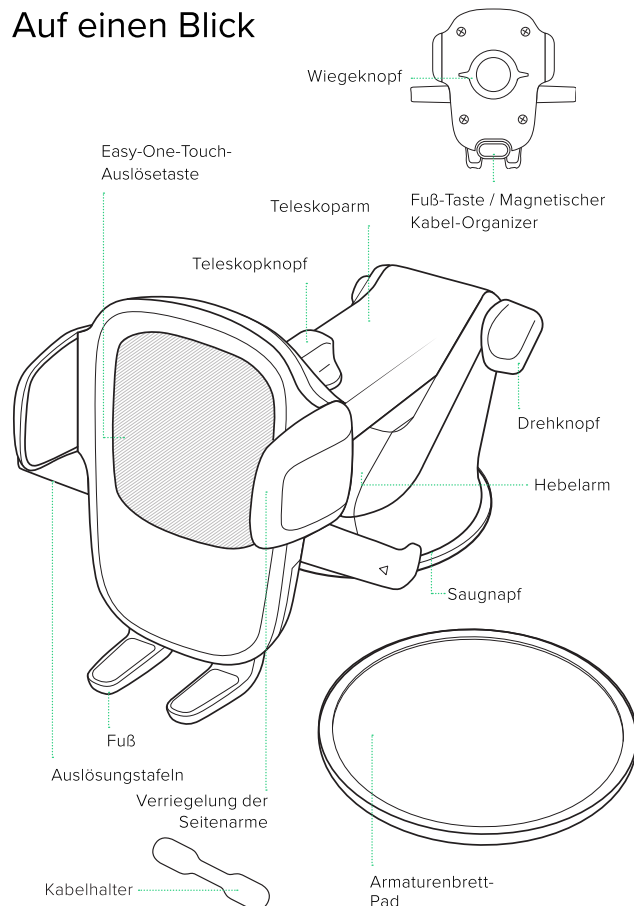

# Installation

## Montage der Halterung

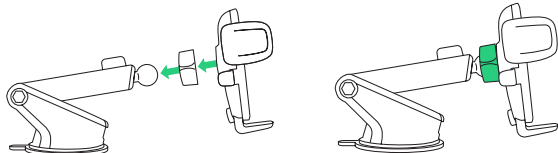

1. Verbinden Sie die Montagehalterung mit dem Kugelgelenk.
2. Dann ziehen Sie den Wiegeknopf fest.

## Befestigung der Halterung

Wählen Sie eine Installationsmethode: Armaturenbrett / flache Oberfläche (A) oder Windschutzscheibe / gebogenes Glas (B).

- ! Wenn Ihr Fahrzeug ein ledernes Armaturenbrett hat, empfehlen wir die Montage an der Windschutzscheibe, um eine Beschädigung des Armaturenbretts zu vermeiden.

### [ Option A ] Installation von Armaturenbrett oder flacher Oberfläche

Wählen Sie einen Bereich auf einer flachen Oberfläche auf dem Armaturenbrett des Fahrzeugs und wischen Sie Staub oder Schmutz von der Oberfläche ab.

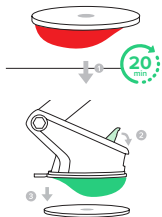

1. Ziehen Sie den Film vom Armaturenbrett-Pad ab und kleben Sie den gewünschten Installationsort fest. Warten Sie 20 Minuten.
2. Ziehen Sie den Schutzfilm vom Saugnapf ab und drücken Sie die Halterung fest auf das Armaturenbrett-Pad.
3. Drücken Sie den Verriegelungshebel nach unten, um die Absaugung zu aktivieren.

- ! Beim Entfernen der Armaturenbrett-Unterlage ist Vorsicht geboten. Wir empfehlen ein langsames Entfernen vom Rand aus, um Schäden zu vermeiden.

### [ Option B ]

### Windschutzscheibeninstallation oder gebogene Glasinstallation

Wählen Sie einen Ort an der Windschutzscheibe und wischen Sie Staub oder Schmutz von der Oberfläche ab.

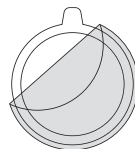

1. Ziehen Sie den Schutzfilm vom Saugnapf ab und drücken Sie die Halterung fest auf die Windschutzscheibe.

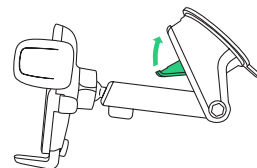

2. Drücken Sie den Verriegelungshebel nach unten, um die Absaugung zu aktivieren.

- ! Ein Verwenden der Armaturenbrett-Unterlage auf der Windschutzscheibe wird nicht empfohlen.

## Zusatzinformationen

- ! Um den Saugnapf wiederzuverwenden, spülen Sie ihn einfach unter warmem Wasser ab und lassen Sie ihn an der Luft trocknen, um die haftende Saugfähigkeit wiederherzustellen.
- ! Verwenden Sie den magnetischen Kabel-Organizer, um Ihr Kabel an Ort und Stelle zu halten und nicht im Weg zu sein.

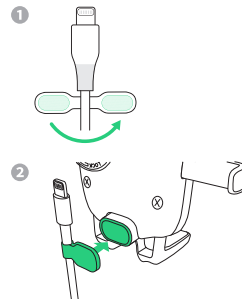

# Verwenden von Easy-One-Touch Mechanismus

Mit dem Easy-One-Touch-Verriegelungs- und Freigabemechanismus können Sie Ihr Smartphone in Sekundenschnelle montieren und abholen.

## Einbau

1. Drücken Sie die Verriegelungsseitenarme ein.

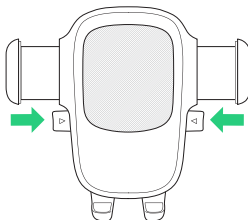

2. Drücken Sie Ihr Gerät gegen die Easy-One-Touch-Auslösetaste. Die Arme der Halterung schließen sich bei Berührung automatisch und halten das Gerät während der Fahrt.

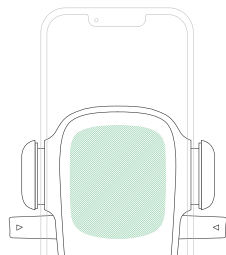

## Freigabe

Drücken Sie die Verriegelungsseitenarme mit einer Hand und holen Sie das Gerät ab.

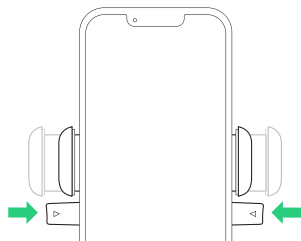

# Einstellung der Halterung

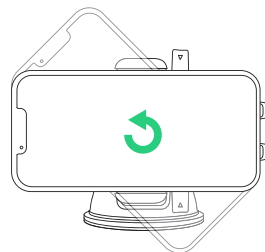

## Wiegekнопf

Wenn Sie im Querformat montieren, lösen Sie die Wiege, um sie zu drehen. Ziehen Sie sie fest, um die gewünschte Position festzulegen.

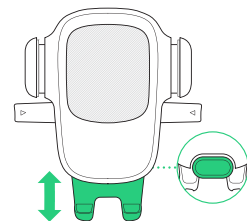

## Fuß-Taste

Befindet sich auf der Rückseite der Halterung. Drücken Sie den Knopf, um den Fuß der Halterung neu zu positionieren. Der Fuß kann nach oben und unten verstellt werden, damit er für jede Telefongröße passt.

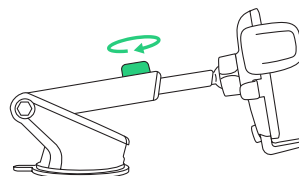

## Teleskopknopf

Sich auf dem Teleskoparm befindend, lockern Sie den Arm und ziehen Sie ihn fest, um den Abstand zu sichern.

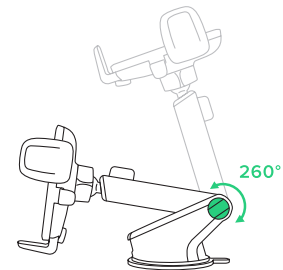

## Drehknopf

An der Seite der Montagesockel gelegen, durch Drehen können Sie den Teleskoparm schwenken. Ziehen Sie in fester Position fest.

## Empezando

Para conseguir un fijación ideal, siga atentamente las instrucciones que se incluyen en este manual al usar el Easy One Touch 5. ¡Ottie no es responsable por posibles daños debidos al uso incorrecto del producto.

## Información importante

La almohadilla para el tablero de instrumentos se fija con una cinta adhesiva semipermanente. Cada almohadilla se usa una sola vez. Una vez retirada, no se puede volver a colocar. Antes de montar el producto, recomendamos que la superficie y el producto estén por encima de los 65°F.

## Especificaciones

ARTICULO	ESPECIFICACIONES
PROFUNDIDAD	16.5 cm
ANCHO	10.7 cm
ALTURA	9.9 cm
PESO	204 g

! El brazo telescópico se extiende de 11.4 cm a 17.2 cm.

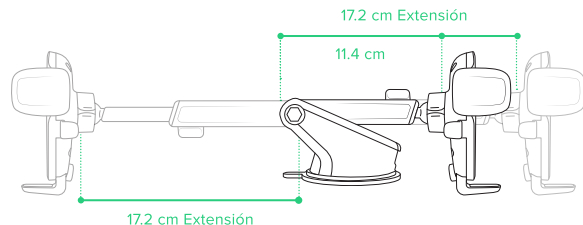

## De un vistazo

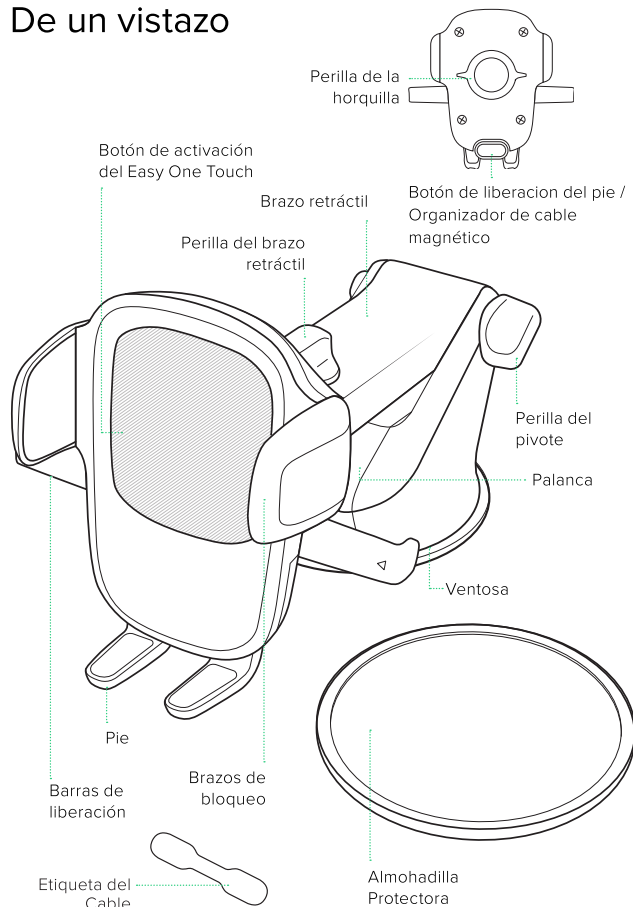

# Instalación

## Colocación del soporte

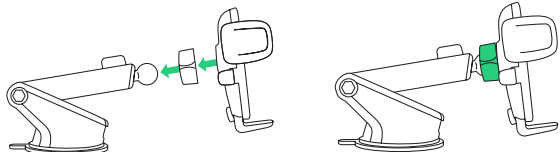

1. Conecte la horquilla a la junta esférica.
2. Apriete la perilla de la horquilla.

## Instalando el soporte

Elija un método de instalación: Tablero de instrumentos/ superficie plana (A) o parabrisas/vidrio curvado (B).

! Si su vehículo tiene un tablero de cuero, recomendamos el montaje en el parabrisas para evitar dañar al tablero.

### [ Opción A ] Instalación en el tablero o en una superficie plana

Elija un área en una superficie plana en el tablero del vehículo y limpie todo el polvo o residuos de la misma.

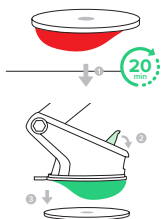

1. Quite el papel protector de la almohadilla del tablero y péguela en el lugar que desee. Espere entre 20 minutos antes de proceder al siguiente paso.
2. Quite el papel protector de la ventosa y presione firmemente el soporte sobre la almohadilla del tablero.
3. Presione hacia abajo la palanca de bloqueo para activar la succión.

! Tenga cuidado a retirar la almohadilla protectora. Recomendamos retirarla lentamente desde el borde para evitar daños.

### [ Opción B ] Instalación en parabrisas o vidrio curvo

Elija un lugar en el parabrisas y limpie el polvo o residuos de la superficie.

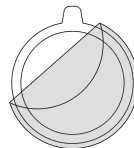

1. Quite el papel protector de la ventosa y presione firmemente el soporte sobre el parabrisas.

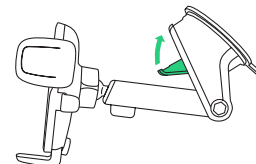

2. Presione hacia abajo la palanca de bloqueo para activar la succión.

! No se recomienda usar la almohadilla protectora para el montaje del para-brisa.

## Información adicional

! Para reutilizar la ventosa, simplemente enjuague con agua tibia y deje que se seque al aire para restaurar la succión pegajosa.

! Utilice el organizador de cables magnético para mantener el cable en su lugar y fuera del camino.

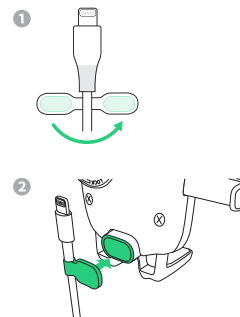



# Uso del mecanismo Easy One Touch

El mecanismo de bloqueo y desenganche Easy One Touch hace que sea fácil colocar y retirar teléfonos inteligentes en cuestión de segundos.

## Colocación

1. Presione los brazos de bloqueo.

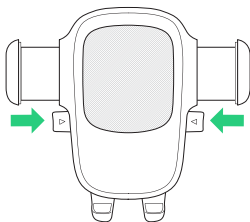

2. Presione su dispositivo contra el botón de activación del Easy One Touch. Los brazos de la montura se cerrarán automáticamente al entrar en contacto y sujetarán el dispositivo durante el viaje.

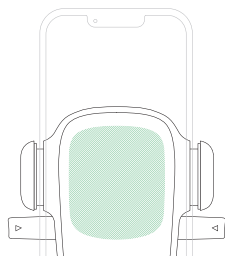

## Retirar

Presione los brazos de bloqueo con una mano y retire el dispositivo.

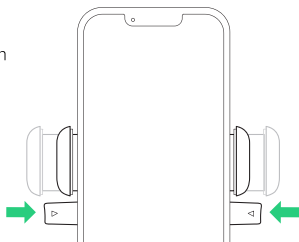

# Ajuste del soporte

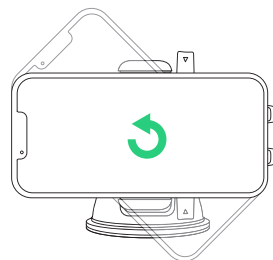

## Perilla de la horquilla

Cuando lo instale en modo horizontal, afloje la perilla para girar la horquilla. Apriétela para fijarla en la posición deseada.

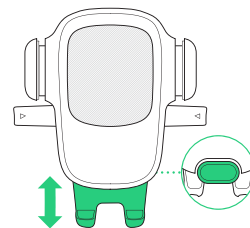

## Botón de liberación del pie

Ubicado en la parte trasera de la montura. Presione el botón para volver a colocar el pie de montaje.

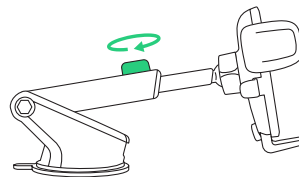

## Perilla del brazo retráctil

Use la perilla ubicada en la parte superior del brazo extensible, aflóielas para extender el brazo y apriétela para fijar su longitud.

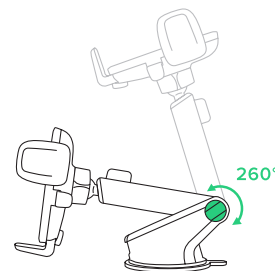

## Perilla del pivote

Use la perilla ubicada en un lado de la base del soporte, aflóielas para mover el brazo extensible. Apriétela para fijar la posición.



**Easy One Touch 5 is backed by  
a 2 year warranty.**

**Request your warranty here**

<https://www.iottie.com/support/customerservice>





**EN** If you love your iOttie product, let us know by leaving a review online, or connect with us on our social platforms.

**FR** Si vous aimez votre produit iOttie, merci de nous le faire savoir en laissant un commentaire en ligne ou nous rejoindre sur nos réseaux sociaux.

**IT** Se ami il tuo prodotto iOttie, faccelo sapere lasciando una recensione online o sulle nostre piattaforme social.

**DE** Wenn Sie von Ihrem iOttie-Produkt begeistert sind, lassen Sie es uns bitte wissen, indem Sie eine Bewertung online abgeben oder sich mit uns auf unseren sozialen Plattformen verbinden.

**ES** Si le gusta su producto iOttie, háganos saber dejando una reseña en línea, o conéctese con nosotros en nuestras plataformas sociales.

 [www.iottie.com](http://www.iottie.com)  [cs@iottie.com](mailto:cs@iottie.com)

**iottie**